

THE CLARK PINK: DIAMOND & DRAMA QUEENS 18" PATTERN

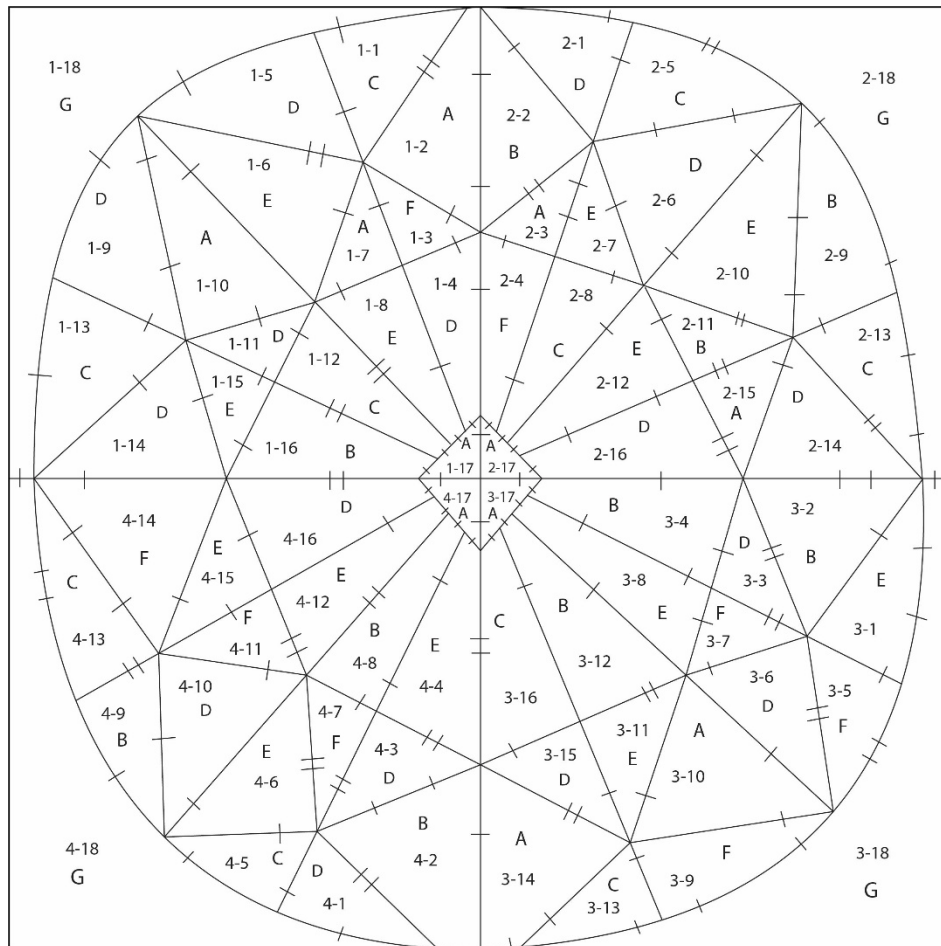

Our *Diamonds & Drama Queens* pattern is inspired by the **Clark Pink**, a spectacular 9-carat, Belle Epoque cushion-cut diamond owned by Huguette Clark. The fancy vivid purplish-pink diamond was the star of the show when Christie's auctioned it in 2012. Expected to fetch \$6-8 million, the winning bid was \$15.7 million, making it the most valuable pink diamond ever sold in the United States.



Huguette Clark (pronounced "oo-get") was one of the last heiresses of the Gilded Age when she died in 2011, just a week shy of her 105th birthday. Her father, William A. Clark, built his fortune on mining and banking. While his contribution to American history is great, his story is largely forgotten likely because of a spectacularly corrupt political campaign he ran at the turn of the century.

Huguette's own history was unknown for most of her life...and she liked it that way. A deeply private person, she loved art, illustration, and music. She cared little for the trappings of wealth, preferring instead to live a quiet life devoted to commissioning detailed miniature houses for her collection of porcelain dolls and Japanese figurines. She was smart, generous, and independent.

The pattern above showcases the cushion-cut shape with pavillion facets radiating outward from the culet. Enjoy!

THE CLARK PINK: DIAMOND & DRAMA QUEENS 18" PATTERN

A - Lightest Light (or White)

E - Dark

B - Light

F - Darkest Dark (or Black)

C - Medium-Light

G - Background

D - Medium-Dark

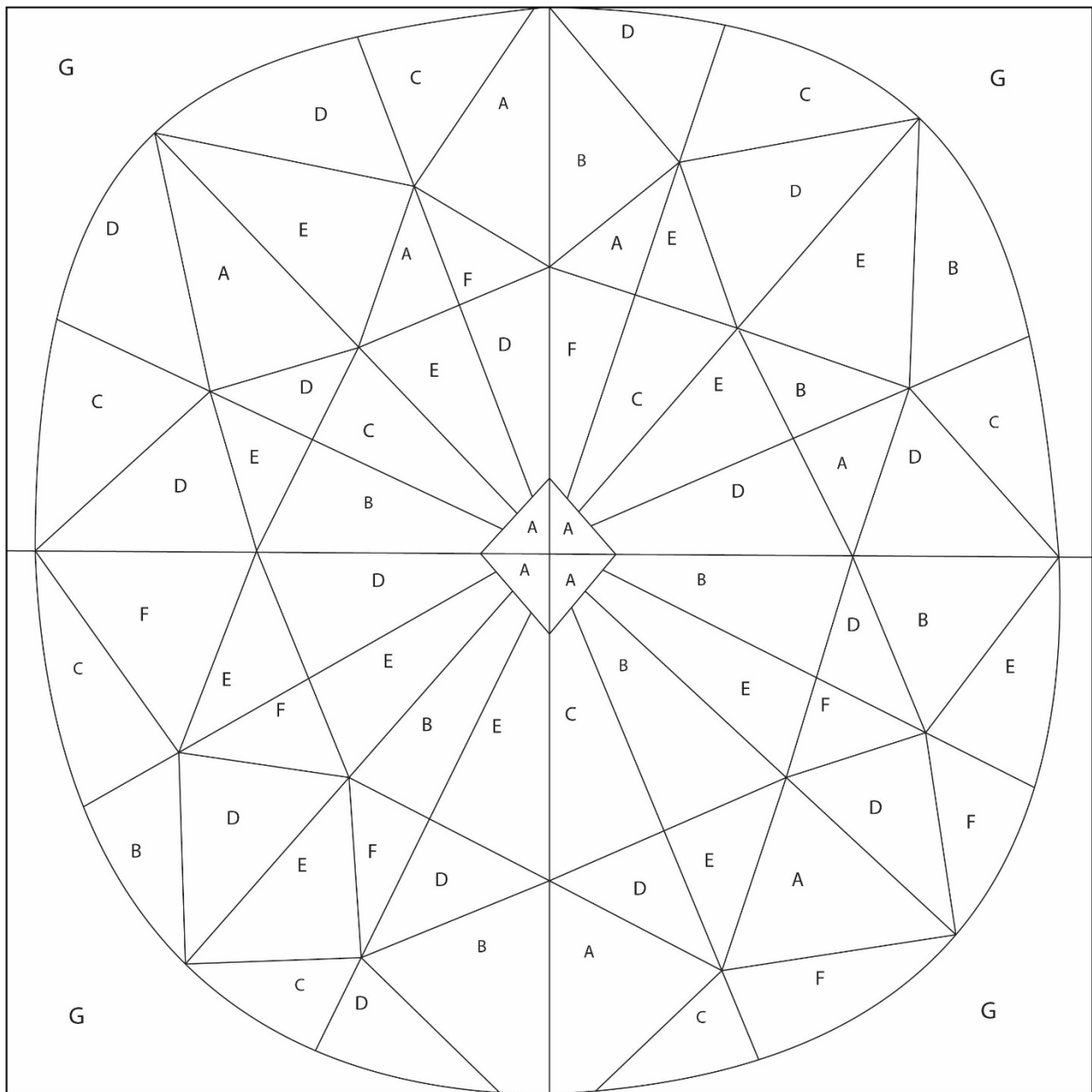

Supplies

THE CLARK PINK: DIAMOND & DRAMA QUEENS 18" PATTERN

- Freezer paper – You can purchase a roll of freezer paper from the grocery store (Reynold’s Freeze Paper). Be sure that you’re not purchasing wax paper or parchment paper. Neither of these products will work with this project. You can also purchase pre-cut sheets that are commercially available. One product is Quilter’s Freezer Paper by C&T Publishing, available on Amazon.com.
- Highlighter pens in 2 colors
- Fabric marking chalk or pen
- Double-sided tape or “Washi” tape (can be found at any crafting store like Joanne’s, Michaels, etc.)
- 18” or 24” ruler with a 1/4” measurement
- Small ruler (12”) with a 1/4” measurement
- 7 envelopes or plastic baggies to store your facets
- Domestic sewing machine and thread assortment (neutrals or colors that match your fabrics)
- Scissors and rotary cutting tools (cutters and mat) – We’ll be cutting both paper and fabric, so if you prefer to use 2 rotary cutters (one with an old blade and one new one) that would be ideal.
- Iron and ironing pad (or board)
- Pins, clips, or fabric glue
- 7 Fabrics according to the colorway chart

Instructions

Preparation

1. Print pages 12-17 of this document with the “Actual Size” print option selected onto a piece of 8.5” x 11” freezer paper. Printing “Actual Size” will ensure that your segments will print out so that your block will be exactly 18” square. This is the chart you will cut up.

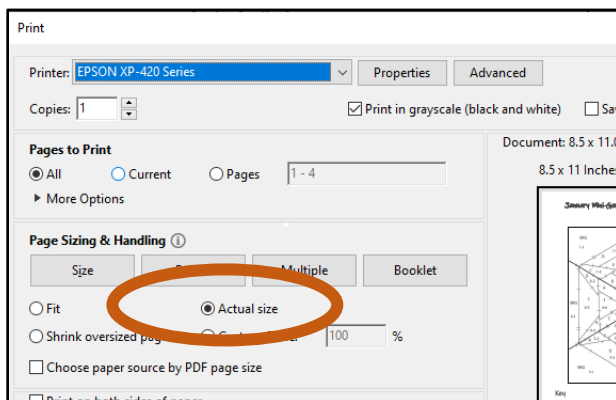

2. Assemble the 2 pieces of each quadrant with either double-sided tape or Washi tape, aligning the facet lines.

THE CLARK PINK: DIAMOND & DRAMA QUEENS 18" PATTERN

- a. If you are using double-sided tape, cut along the outside of the extra tab on the small section. You'll place the double-sided tape on this tab and cover it with the adjacent section, being sure none of the double-sided tape is showing on the front.
 - b. If you are using Washi tape, you don't have to include the tab on the smaller section. Just cut out each of the 2 sections in each quadrant, align the facets, and place the Washi tape on the top of the pattern to join them. You can do this because it's possible to iron over Washi tape without ruining your iron.
3. If you're using double-sided tape, take one of your highlighter pens and mark the center vertical lines in each quadrant where you assembled the segments. This will be your reminder to NOT cut apart facets on this line. If you do, you will be cutting apart facets that are meant to remain whole.

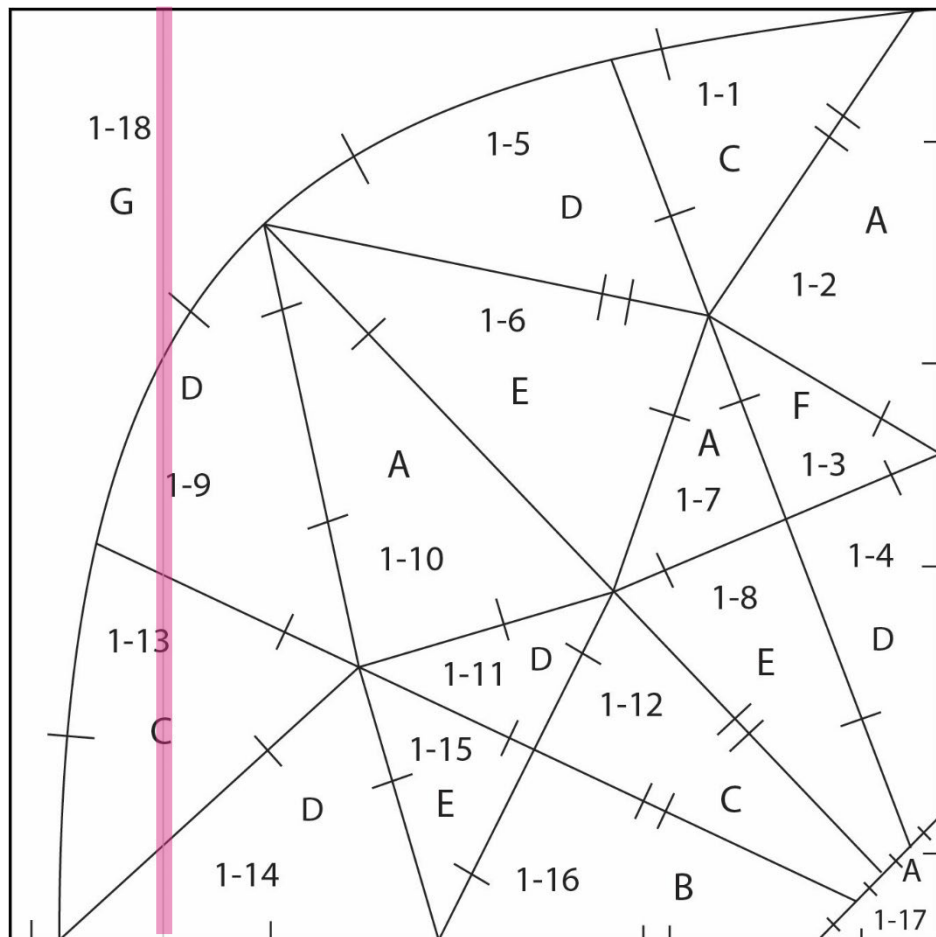

4. Print pages 12-17 of this document onto regular paper using the "Actual Size" setting. This will be the copy you will pin or tape to your quilt room wall. It will be your KEY to help you put your block back together.
5. Identify 7 fabrics in a range of values to use in your block. On page 2, you'll find a pattern with just the color codes in place. You can use this to experiment with colorways. I've also provided a Colorway diagram featuring the pattern in a

THE CLARK PINK: DIAMOND & DRAMA QUEENS 18" PATTERN

pinkish lavender colorway and a diamond colorway.

6. Attach a snippet of fabric next to each code of the corresponding value (i.e., light, medium, dark) OR label your fabric by writing the code on the selvedge edge or corner of the corresponding fabric.
7. Gather 7 business size envelopes or plastic baggies in which you'll store your facets once cut apart. Label them with the letters A, B, C, D, E, F and G to correspond to your fabric codes.

Cutting Your Facets

8. With your second highlighter pen, trace the inside edge of the block on your FREEZER PAPER. This is the visual clue that will remind you to put the edges of these pieces on the straight of grain when you're ironing on the facets to the fabric. (The straight of grain is the grainline that runs parallel to the selvedge edge.) This step gives the block more stability. Here's an example of what Section 1 will look like:

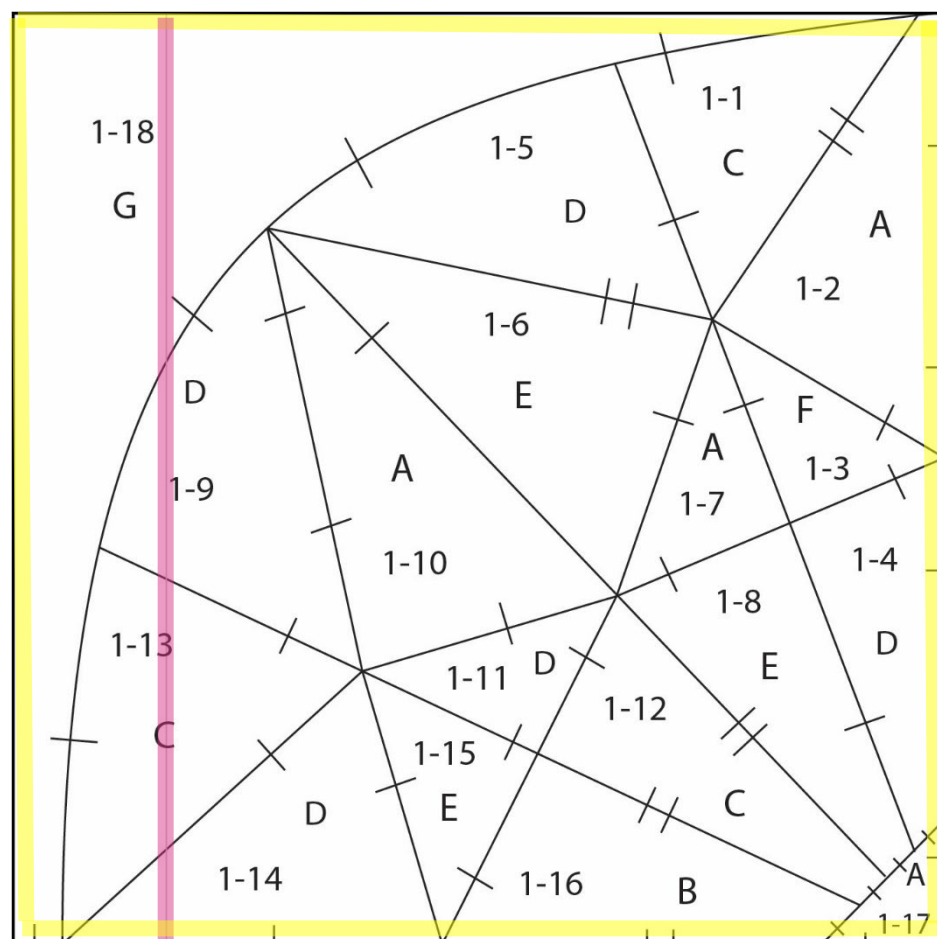

THE CLARK PINK: DIAMOND & DRAMA QUEENS 18" PATTERN

9. With a ruler and rotary cutter, you reserve for cutting paper, cut apart the freezer paper template and sort facets into the envelopes or baggies by letter code. I personally like to use hand scissors when cutting curves.

Note: If your ruler slips off the line a little bit, no problem! Just don't trim it up. Just be sure that you can still see any hashmarks on either side of the cut.

10. Arrange facets on the RIGHT SIDE of the fabric that corresponds to their color code, allowing $\frac{3}{4}$ " of space between each facet. Press with a hot iron, no steam.

If the freezer paper isn't adhering very well to the fabric, try heating the fabric first and then laying the freezer paper piece on top of it and press it down. (If you have lots of sizing or dye in your fabric, you may want to pre-wash your fabric. Extra chemicals sometimes prevent freezer paper from sticking to fabric.)

11. Once all your facets are ironed to the RIGHT SIDE of the fabric, relabel 4 of your envelopes or baggies with the numbers 1 through 4, corresponding to the 4 sections of the block.
12. Using a rotary cutter and small ruler, cut out each facet with a $\frac{1}{4}$ " seam allowance. Take care to make these $\frac{1}{4}$ " seam allowances as accurate and consistent as possible. Place the fabric facets in your envelopes or baggies by section number (i.e., 1 through 4).
13. Once all your facets are cut out and stored in their respective envelopes, remove the facets from the envelopes one by one and lay them out in numerical order to make sure that one hasn't accidentally wandered away.

Piecing Your Gem

14. Arrange facets into their piecing order using the chart you put up on your quilt room wall as your guide.

NOTE: I have created a "Piece Plan" that provides a step-by-step process to assemble the block. You'll find it at the end of this document.

15. To piece your facets, place RIGHT SIDES together (freezer paper will be inside the fabric sandwich).
16. Peek inside the seam allowance and line up the hash marks on each side of the two pieces. Ensure that the corners of each facet line up together.

THE CLARK PINK: DIAMOND & DRAMA QUEENS 18" PATTERN

17. Pin carefully along the seam OR use a clip OR use a glue product to secure the 2 pieces together.
18. Identify the 1/4" seam guide on your machine's plate.
19. Position the pair of pinned facets under the presser foot so that the edge of your fabric sandwich is just a needle-width to the left of the 1/4" seam guide. This will prevent you from sewing into the freezer paper on the inside.
20. Stitch the seam line using a regular stitch length (i.e., 2.5). I backstitch at the beginning and the end only because it's been my habit to do so for 20 years. Some have said that's not a necessary step for them. Habits die hard!
21. Open the facets with both seams to one side. (Press to the darkest side OR the side that has the fewest intersecting seams.)
 - a. If there is a gap between the edges of your freezer paper, you can either re sew a little bit closer to the 1/4" seam guide OR you can pick up one of the templates and iron it next to the seam. Just be sure to trim the seam allowance down to 1/4".
 - b. If you have sewn into the freezer paper, give the two pieces a little tug to see if this frees the freezer paper. If you've really munched the freezer paper, consider ripping that section and re sewing. Gaps and tucks change the position of the hashmarks along the sides of the 2 facets, which makes it a bit confusing when trying to match it up to its adjoining unit. In the end, though, perfection is NOT a priority and, once you've removed all the paper from your gem, no one will know the difference!
22. Continue to stitch the facets together, retaining the freezer paper on the front of each piece.
23. If facets come loose, simply iron back on.

TIP: If you want to remove the freezer paper after piecing major sections together, be sure to draw the hash marks onto the seam allowance before removing the freezer paper.

24. The background pieces (all marked as the 18th piece) are the last to be sewn to the section. It's hard to piece curves with the freezer paper on the fabric, so you'll want to remove the freezer paper before easing the curved background piece to the curved edge of the gem.

THE CLARK PINK: DIAMOND & DRAMA QUEENS 18" PATTERN

However, before you do so, be sure to draw the hash marks onto the seam allowance **before removing the freezer paper**. Those hashmarks will be extremely helpful as you ease the two curves together.

25. Once the gem is complete, remove the remaining freezer paper pieces and store them in your envelopes or baggies by color code if you plan on using them again. You can typically get 2 uses out of regular freezer paper, but I know some people who can squeeze 3 and even 4 uses out of their freezer paper pieces!
26. If little bits of freezer paper are stuck in the seam line, use a pair of tweezers to remove. If they are stubborn, try using seam ripper to remove them by pushing the bit of paper from the front to the back side of the fabric. Use tweezers to pull from between the seams.

CONGRATULATIONS!

PIECE PLAN FOR 'THE CLARK PINK'

Section 1

- Sew together 1-1, 1-2, 1-3 and 1-4 (to create Unit 1:4)
- Sew together 1-5, 1-6, 1-7 and 1-8 (to create Unit 5:8)
- Sew together 1-9, 1-10, 1-11 and 1-12 (to create Unit 9:12)
- Sew together 1-13, 1-14, 1-15 and 1-16 (to create Unit 13:16)
- Sew together Unit 1:4, Unit 5:8, Unit 9:12 and Unit 13:16 (to create Unit 1:16)
- Sew together Unit 1:16 and 1-17 (to create Unit 1:17)
- With a fabric marking pencil or chalk, extend the hashmarks into the seam allowances of Unit 1:17 and 1-18
- Once the hashmarks are marked in the seam allowance, remove the freezer paper from these Unit 1:17 and 1-18.
- Sew together Unit 1:17 and 1-18, easing in the gentle curve and aligning the hashmarks in the curved seam allowance (to complete Section 1)

Section 2

- Sew together 2-1, 2-2, 2-3 and 2-4 (to create Unit 1:4)
- Sew together 2-5, 2-6, 2-7 and 2-8 (to create Unit 5:8)
- Sew together 2-9, 2-10, 2-11 and 2-12 (to create Unit 9:12)
- Sew together 2-13, 2-14, 2-15 and 2-16 (to create Unit 13:16)
- Sew together Unit 1:4, Unit 5:8, Unit 9:12 and Unit 13:16 (to create Unit 1:16)
- Sew together Unit 1:16 and 2-17 (to create Unit 1:17)
- With a fabric marking pencil or chalk, extend the hashmarks into the seam allowances of Unit 1:17 and 2-18
- Once the hashmarks are marked in the seam allowance, remove the freezer paper from these Unit 1:17 and 2-18.

THE CLARK PINK: DIAMOND & DRAMA QUEENS 18" PATTERN

- Sew together Unit 1:17 and 2-18, easing in the gentle curve and aligning the hashmarks in the curved seam allowance (to complete Section 2)

Section 3

- Sew together 3-1, 3-2, 3-3 and 3-4 (to create Unit 1:4)
- Sew together 3-5, 3-6, 3-7 and 3-8 (to create Unit 5:8)
- Sew together 3-9, 3-10, 3-11 and 3-12 (to create Unit 9:12)
- Sew together 3-13, 3-14, 3-15 and 3-16 (to create Unit 13:16)
- Sew together Unit 1:4, Unit 5:8, Unit 9:12 and Unit 13:16 (to create Unit 1:16)
- Sew together Unit 1:16 and 3-17 (to create Unit 1:17)
- With a fabric marking pencil or chalk, extend the hashmarks into the seam allowances of Unit 1:17 and 3-18
- Once the hashmarks are marked in the seam allowance, remove the freezer paper from these Unit 1:17 and 3-18.
- Sew together Unit 1:17 and 3-18, easing in the gentle curve and aligning the hashmarks in the curved seam allowance (to complete Section 3)

Section 4

- Sew together 4-1, 4-2, 4-3 and 4-4 (to create Unit 1:4)
- Sew together 4-5, 4-6, 4-7 and 4-8 (to create Unit 5:8)
- Sew together 4-9, 4-10, 4-11 and 4-12 (to create Unit 9:12)
- Sew together 4-13, 4-14, 4-15 and 4-16 (to create Unit 13:16)
- Sew together Unit 1:4, Unit 5:8, Unit 9:12 and Unit 13:16 (to create Unit 1:16)
- Sew together Unit 1:16 and 4-17 (to create Unit 1:17)
- With a fabric marking pencil or chalk, extend the hashmarks into the seam allowances of Unit 1:17 and 4-18

THE CLARK PINK: DIAMOND & DRAMA QUEENS 18" PATTERN

- Once the hashmarks are marked in the seam allowance, remove the freezer paper from these Unit 1:17 and 4-18.
- Sew together Unit 1:17 and 4-18, easing in the gentle curve and aligning the hashmarks in the curved seam allowance (to complete Section 4)

Putting Sections Together

- Sew together Section 1 and Section 2.
- Sew together Section 3 and Section 4.
- Sew the two halves of your block together, taking care to match the points where the gem and background meet. (See highlighted area below.)

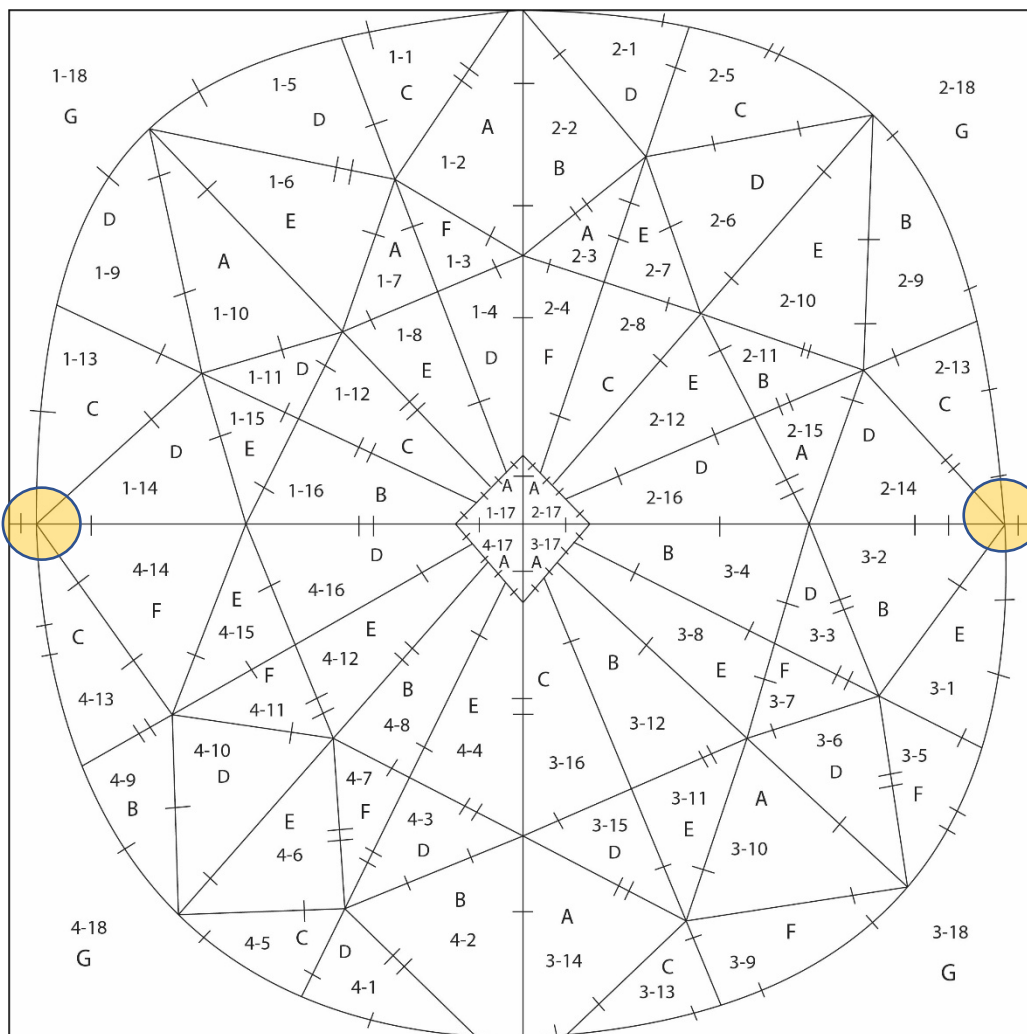

THE CLARK PINK: DIAMOND & DRAMA QUEENS 18" PATTERN

Section 1

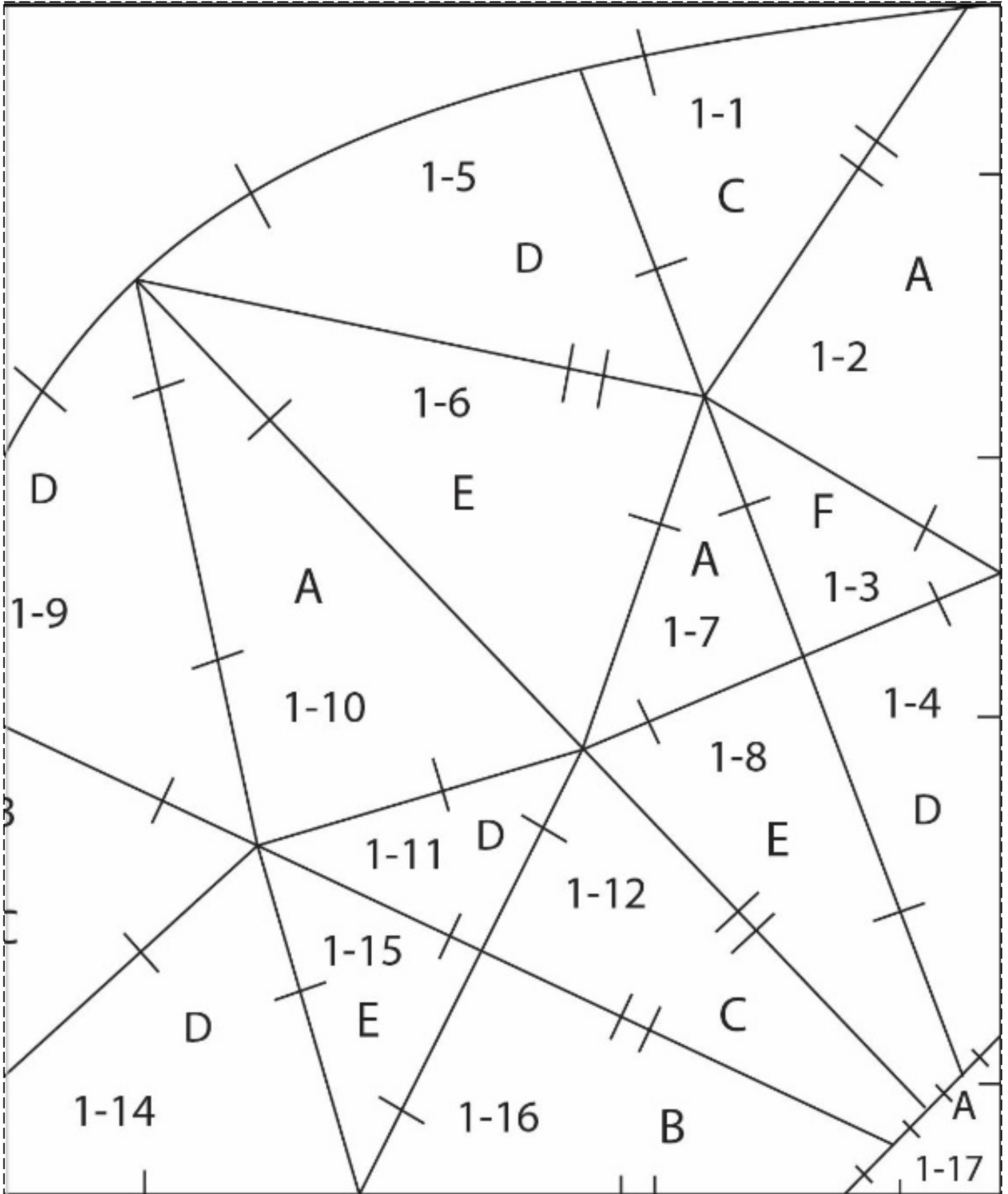

THE CLARK PINK: DIAMOND & DRAMA QUEENS 18" PATTERN

Section 2

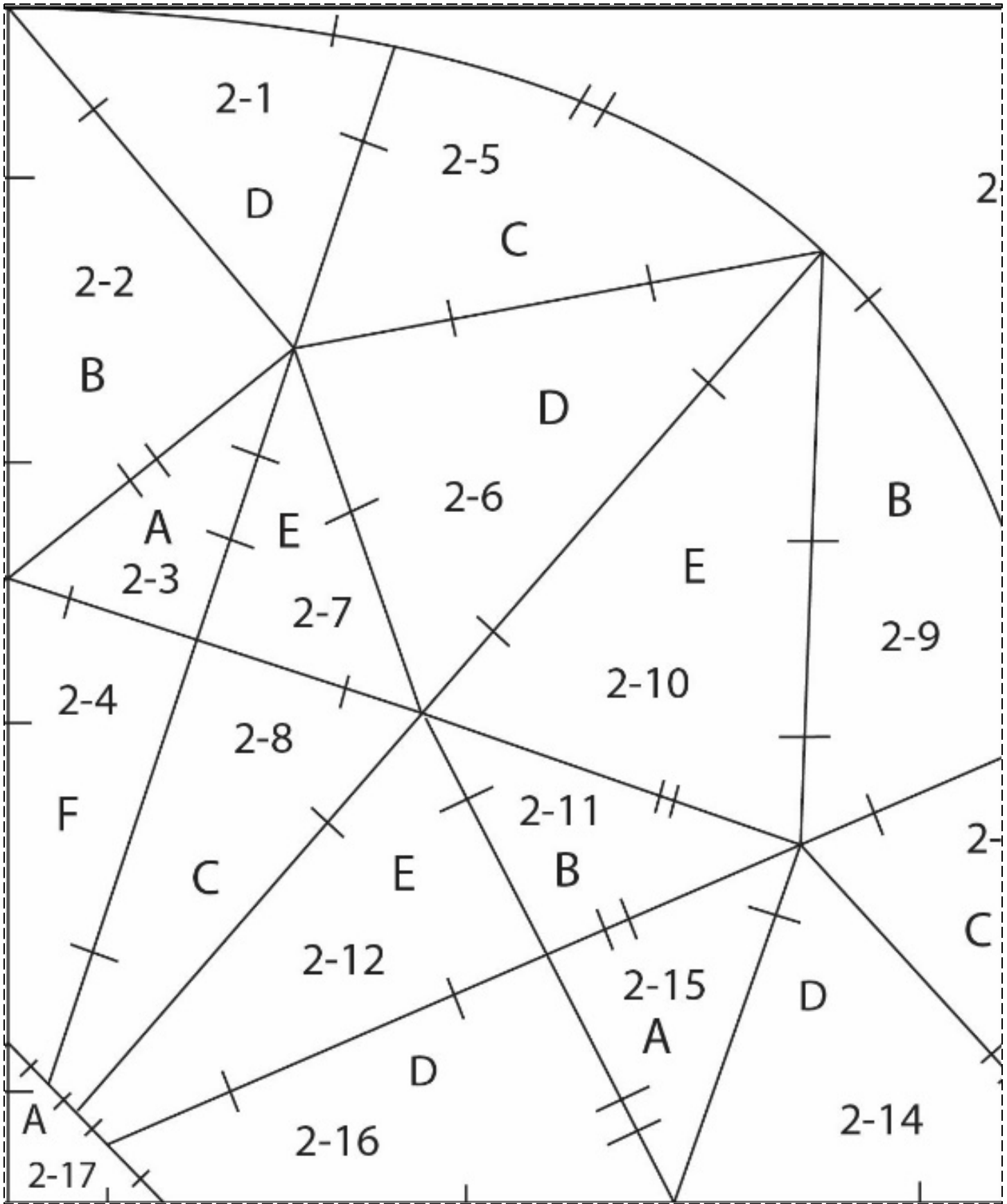

THE CLARK PINK: DIAMOND & DRAMA QUEENS 18" PATTERN

Section 3

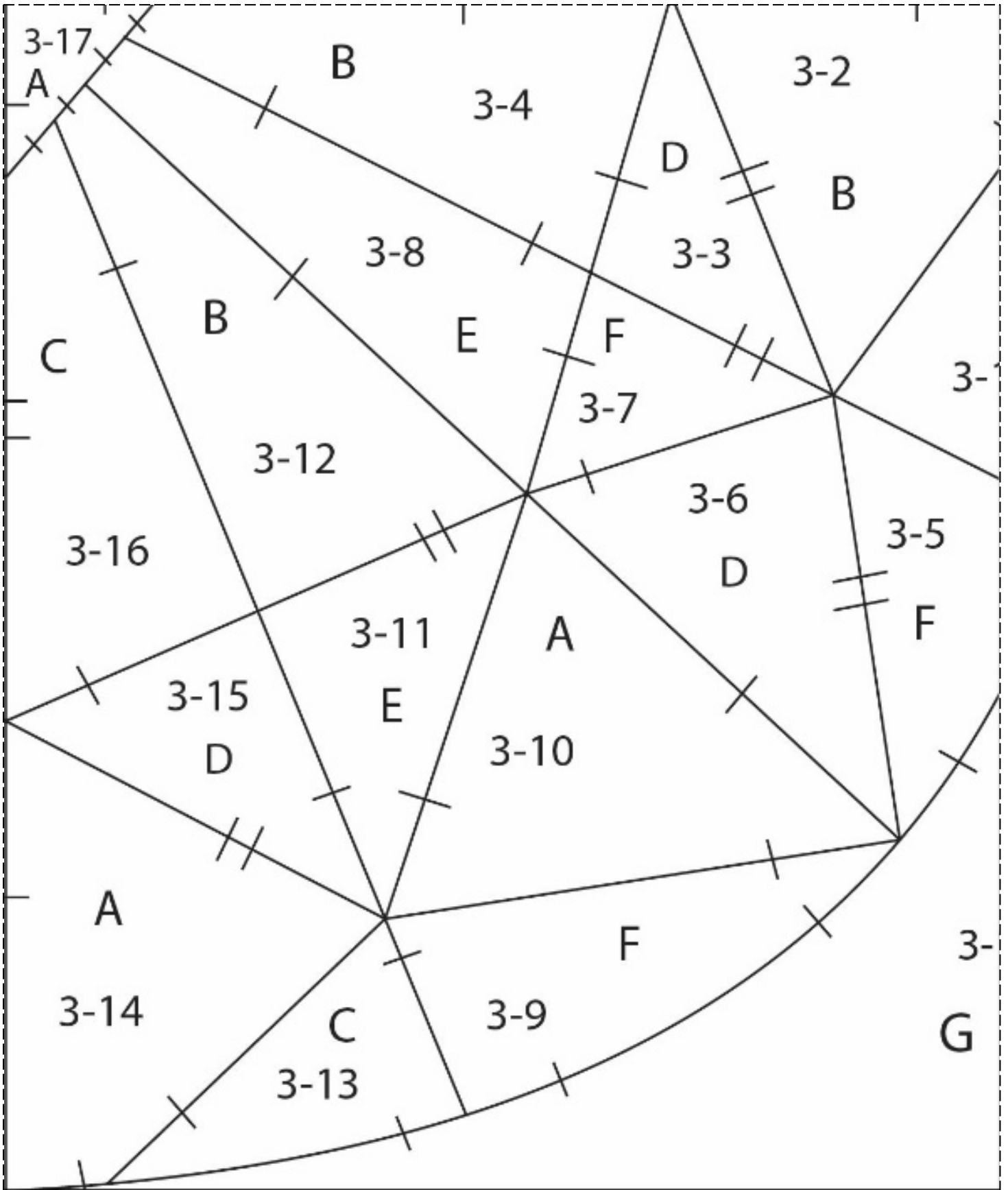

THE CLARK PINK: DIAMOND & DRAMA QUEENS 18" PATTERN

Section 4

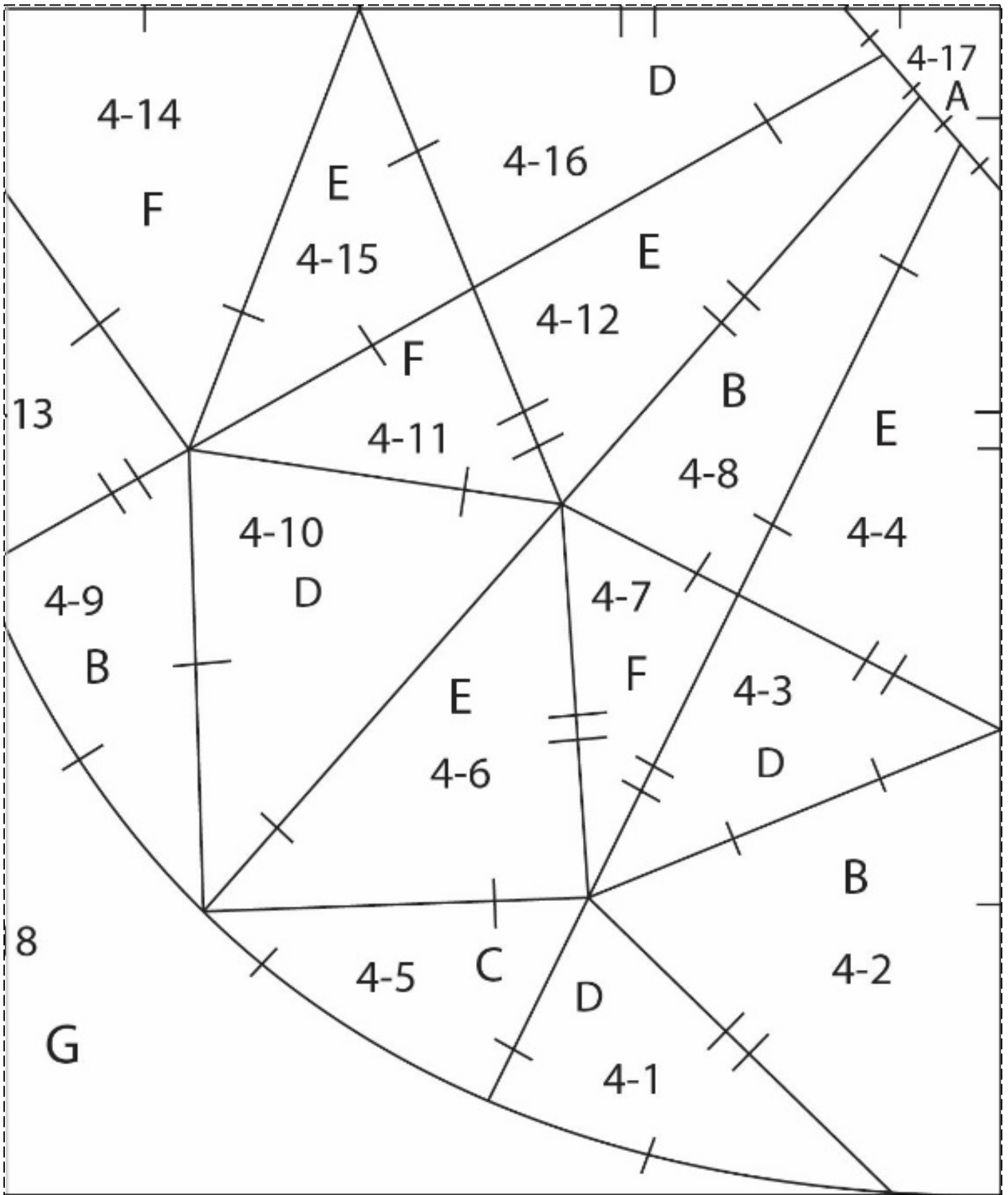

THE CLARK PINK: DIAMOND & DRAMA QUEENS 18" PATTERN

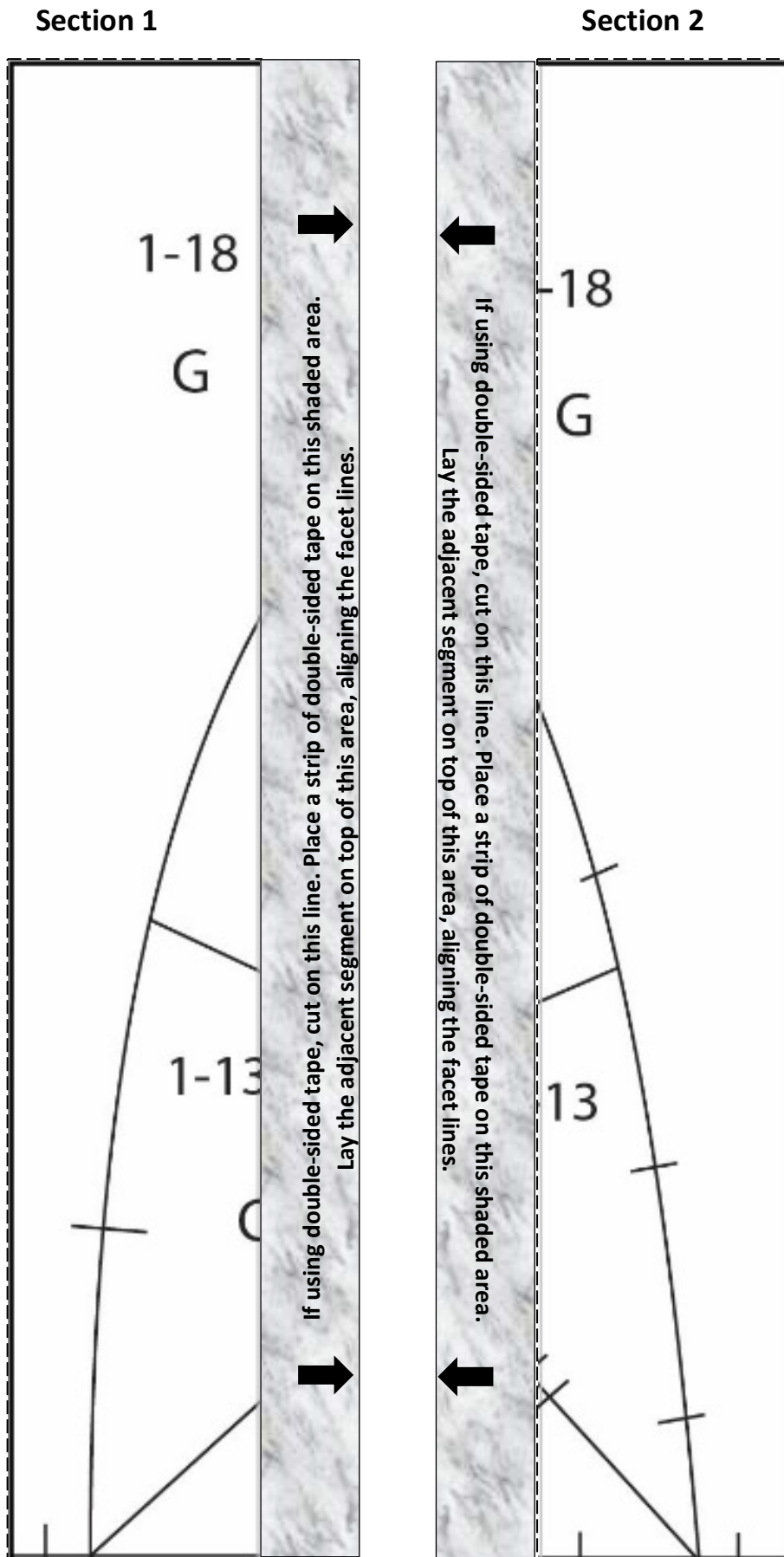

THE CLARK PINK: DIAMOND & DRAMA QUEENS 18" PATTERN

Section 3

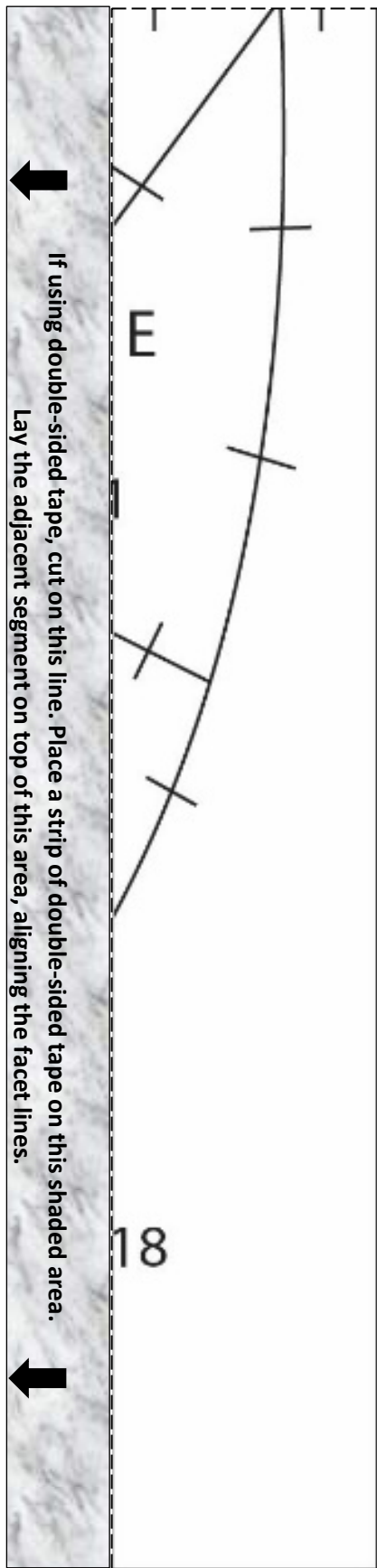

Section 4

